

STANDARD METER SETTING

5M-5

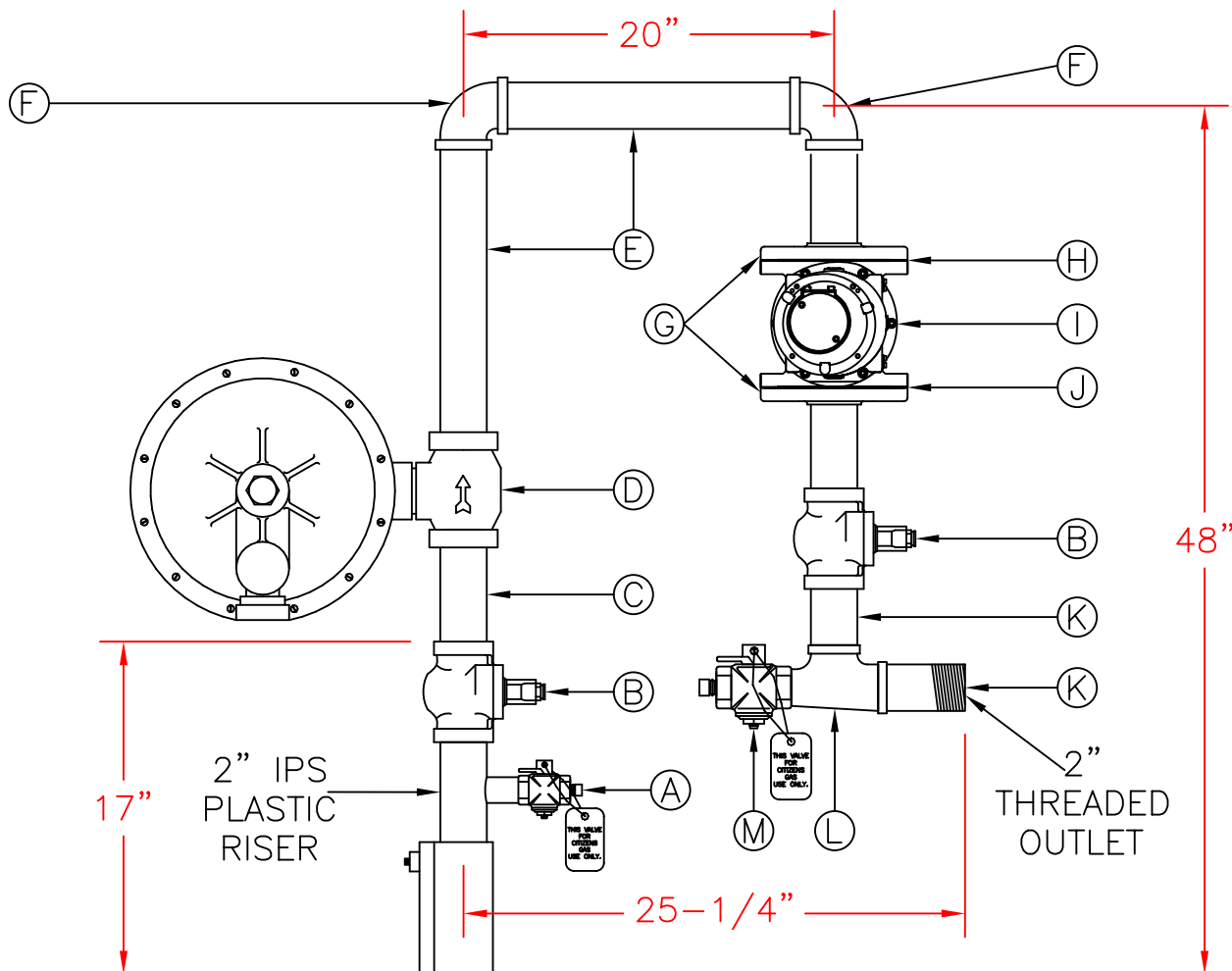

BILL OF MATERIALS

- A: (1) 1" LOCKWING VALVE (W/ BARREL LOCK, SCREWED, PLUG & TAG)
- B: (2) 2" LUBRICATED PLUG VALVE (THREADED)
- C: (1) 2" X 6" NIPPLE
- D: (1) U-152 REGULATOR**
- E: (2) 2" X 16" NIPPLE
- F: (2) 2" 90° ELL
- G: (2) 3" X 2" REDUCING P.W. FLANGE
- H: (1) 3" MESH IN-LINE SCREEN
- I: 3M-175 T.C. ROTARY METER
- J: (1) 3" GASKET
- K: (2) 2" X 4" NIPPLE
- L: (1) 2" X 1-1/2" X 2" REDUCING STREET TEE
- M: (1) 1-1/2" LOCKWING VALVE (W/ BARREL LOCK , SCREWED, PLUG & TAG)

NOTES

**FOR 60 PSIG SYSTEMS USE U-153
 DISTANCE FROM BUILDING: 12"
 ALL DIMENSIONS ARE APPROXIMATE

HIGH PRESSURE METER SETTING
 OUTLET PRESSURE: 5 PSIG

DATE: 02/25/09 DWG. BY: M.A.T.
 DATE: 01/19/99 DWG. BY: C.H.P.
 APPROVED BY: M.J.S.